

# MBR206 0LFCT

Schottky Barrier Diodes Low Forward Voltage  
20 A Total (10A Per Diode Leg)

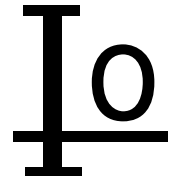

## FEATURES

- Plastic package has Underwriters Laboratory Flammability Classification 94V-0
- Metal silicon junction ,majority carrier conduction
- Guard ring for overvoltage protection
- Low power loss ,high efficiency
- High current capability ,Low forward voltage drop
- High surge capability
- For use in low voltage ,high frequency inverters, free wheeling ,and polarity protection applications
- Dual rectifier construction
- High temperature soldering guaranteed:260° C/10 seconds,, 0.25"(6.35mm)from case
- Component in accordance to RoHS 2011/65/ EU

## MECHANICAL DATA

- Case: JEDEC ITO-220AB molded plastic body
- Terminals: Lead solderable per MIL-STD-750,method 2026
- Polarity: As marked
- Mounting Position: Any
- Weight: 1.81 gram
- \* Lead Free Finish/RoHS Compliant

## VOLTAGE RANGE

60 Volts

## CURRENT

20.0Ampere

## ITO-220AB

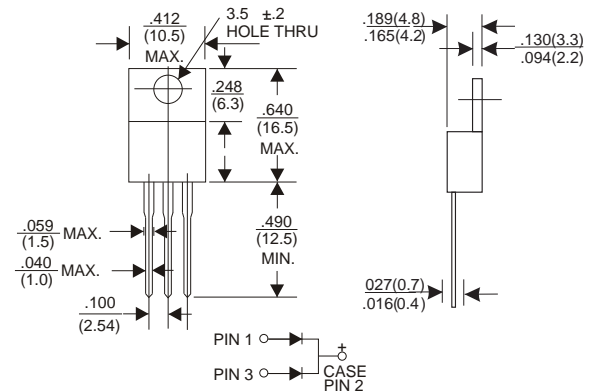

Dimensions in inches and (millimeters)

## RATINGS (Per Diode Leg)

Rating	Symbol	MBR2060LFCT	Unit
Peak Repetitive Reverse Voltage	$V_{RRM}$	60	V
Average Rectified Forward Current (Rated $V_R$ ) $T_C = 133^\circ\text{C}$	$I_{F(AV)}$	10	A
Peak Repetitive Forward Current (Rated $V_R$ , Square Wave, 20 kHz) $T_C = 133^\circ\text{C}$	$I_{FRM}$	20	A
Typical Instantaneous Forward Voltage ( $i_F = 10\text{Amps}$ , $T_C = 25^\circ\text{C}$ )	$V_F$	0.55	V
Nonrepetitive Peak Surge Current (Surge applied at rates load conditions halfwave, single phase, 60Hz)	$I_{FSM}$	200	A
Peak Repetitive Reverse Surge Current (2.0 $\mu\text{s}$ , 1.0 kHz)	$I_{RRM}$	5	A
Operating Junction Temperature	$T_J$	- 65 to +150	$^\circ\text{C}$
Voltage Rate of Change (Rated $V_R$ )	$dv/dt$	10,000	$\text{V}/\mu\text{s}$
Maximum Instantaneous Reverse Current (Rated dc Voltage, $T_C = 125^\circ\text{C}$ ) (Rated dc Voltage, $T_C = 25^\circ\text{C}$ )	$I_R$	100 0.5	mA

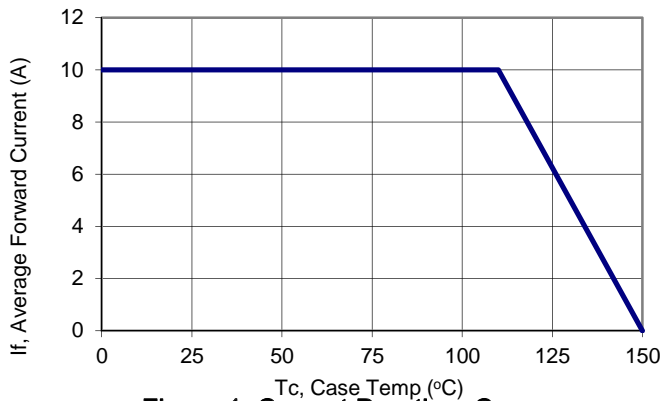

Figure 1: Current Derating, Case

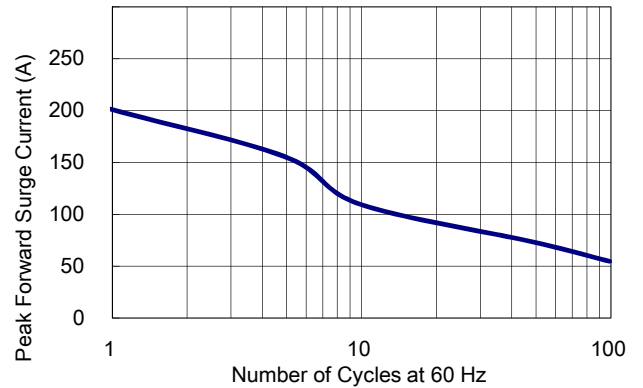

Figure 2: Maximum Repetitive Surge Current

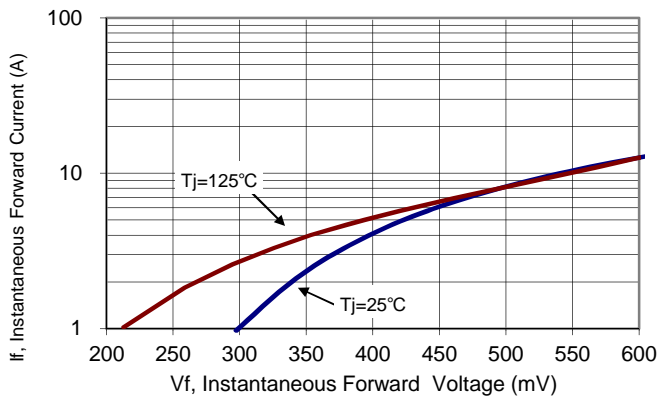

Figure 3: Typical Forward Voltage

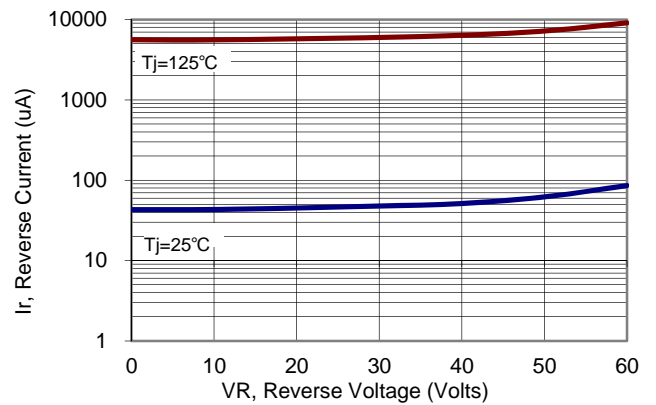

Figure 4: Typical Reverse Current

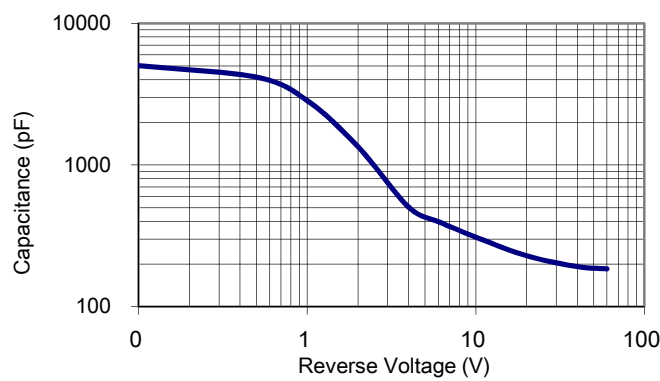

Figure 5: Typical Junction Capacitance