

MMBT9018H

TRANSISTOR (NPN)

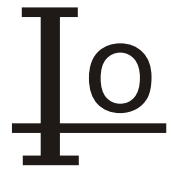

FEATURES

AM/FM Amplifier, Local Oscillator of FM/VHF Tuner
High Current Gain Bandwidth Product $f_T=1.1$ GHz (Typ)

MARKING : J8

SOT-23

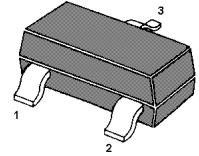

1. BASE
2. EMITTER
3. COLLECTOR

MAXIMUM RATINGS ($T_A=25^\circ\text{C}$ unless otherwise noted)

Symbol	Parameter	Value	Units
V_{CB0}	Collector-Base Voltage	30	V
V_{CE0}	Collector-Emitter Voltage	15	V
V_{EB0}	Emitter-Base Voltage	5	V
I_C	Collector Current -Continuous	50	mA
P_C	Collector Power Dissipation	200	mW
T_j	Junction Temperature	150	$^\circ\text{C}$
T_{stg}	Storage Temperature	-55-150	$^\circ\text{C}$

ELECTRICAL CHARACTERISTICS ($T_{amb}=25^\circ\text{C}$ unless otherwise specified)

Parameter	Symbol	Test conditions	MIN	TYP	MAX	UNIT
Collector-base breakdown voltage	$V_{(BR)CBO}$	$I_C=100\mu\text{A}$, $I_E=0$	30			V
Collector-emitter breakdown voltage	$V_{(BR)CEO}$	$I_C=1\text{mA}$, $I_B=0$	15			V
Emitter-base breakdown voltage	$V_{(BR)EBO}$	$I_E=100\mu\text{A}$, $I_C=0$	5			V
Collector cut-off current	I_{CBO}	$V_{CB}=12\text{V}$, $I_E=0$			0.05	μA
Collector cut-off current	I_{CEO}	$V_{CE}=12\text{V}$, $I_B=0$			0.1	μA
Emitter cut-off current	I_{EBO}	$V_{EB}=3\text{V}$, $I_C=0$			0.1	μA
DC current gain	$h_{FE(1)}$	$V_{CE}=5\text{V}$, $I_C=1\text{mA}$	105		195	
Collector-emitter saturation voltage	$V_{CE(sat)}$	$I_C=10\text{mA}$, $I_B=1\text{mA}$			0.5	V
Base-emitter saturation voltage	$V_{BE(sat)}$	$I_C=10\text{mA}$, $I_B=1\text{mA}$			1.4	V
Transition frequency	f_T	$V_{CE}=5\text{V}$, $I_C=5\text{mA}$ $f=400\text{MHz}$	600			MHz

Typical Characteristics

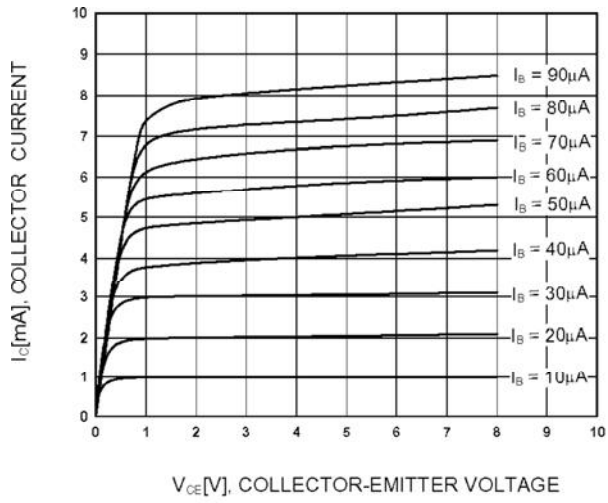

Static Characteristic

MMBT9018H

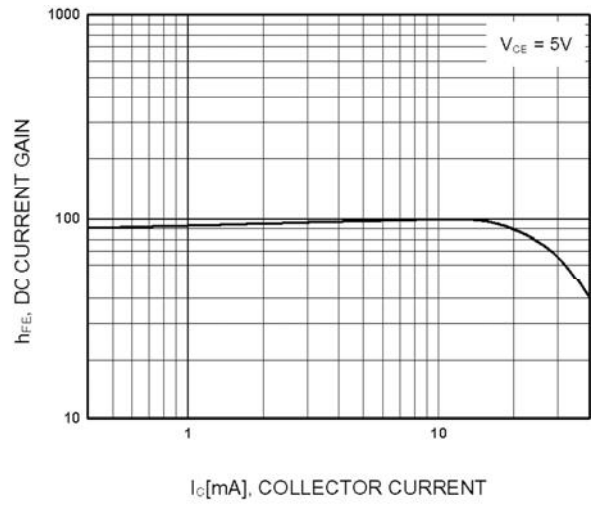

DC Current Gain

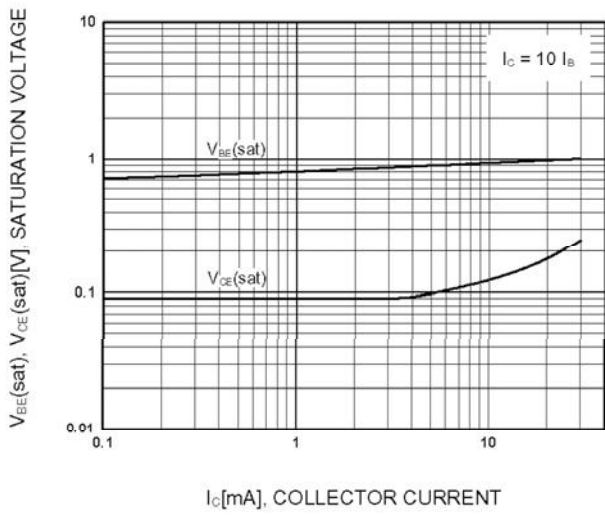

**Base-Emitter Saturation Voltage
Collector-Emitter Saturation Voltage**

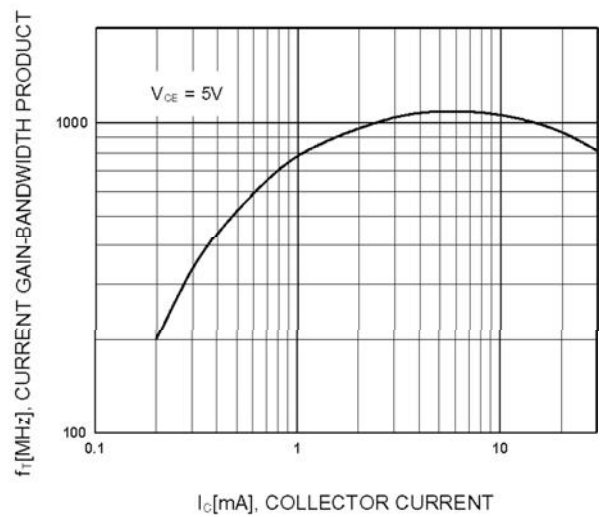

Current Gain Bandwidth Product

PACKAGE OUTLINE

Plastic surface mounted package; 3 leads

SOT-23

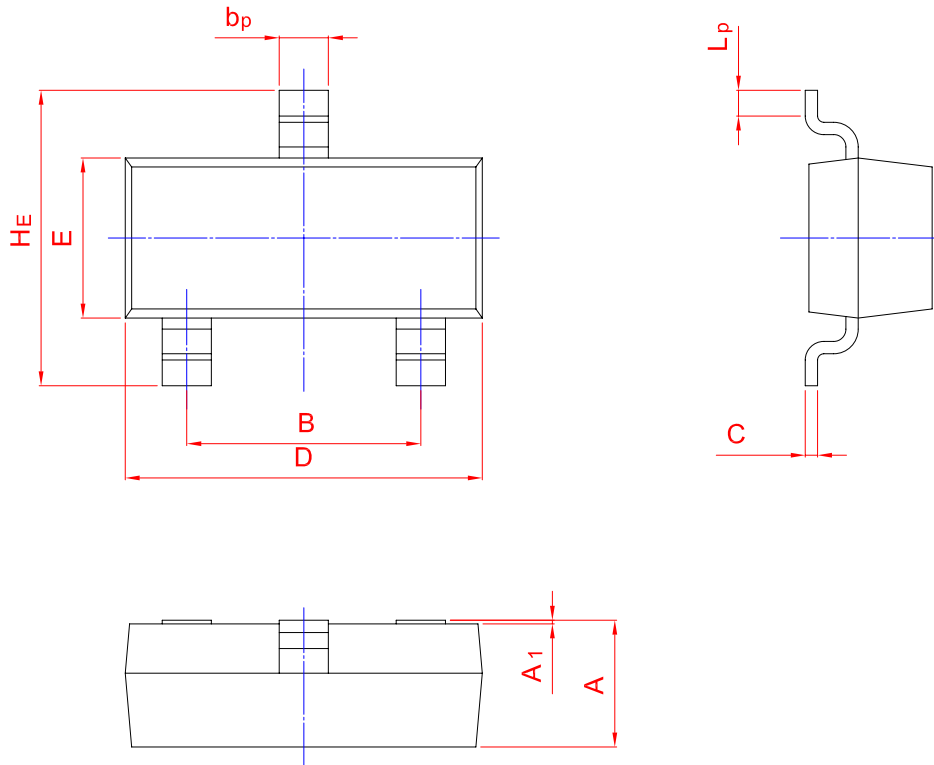
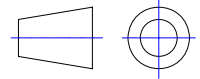

UNIT	A	B	bp	C	D	E	HE	A1	Lp
mm	1.40	2.04	0.50	0.19	3.10	1.65	3.00	0.100	0.50
	0.95	1.78	0.35	0.08	2.70	1.20	2.20	0.013	0.20